



Movexx **T1000-Platform**
ONDERDELEN & OPTIES
2019

Specificaties

Technische gegevens

Frame	Staal, gepoedercoat
Aandrijving	24V DC, 420W, 140 toeren/min
Gewicht	120 kg (incl. accu)
Gew. aanhanger	Max. 1000 kg
Accu	Wisselbare accupack
Snelheid	Max. 6,6 km/h, vrij programmeerbaar
Aandrijfwielen	Massief rubber 250x80 mm
Werkhoogte	750-1261 mm (variabel)
Geluidsniveau	63,8 dB
Gebruikers temp.	-10 °C / 40 °C
Bescherm klasse	Machine IP44

© 2019 Movexx International B.V. The images shown are used for illustration purposes only and may differ from the products indicated. No rights can therefore be derived from it. Printing errors are subjected to change.

Trekkracht (in kg)

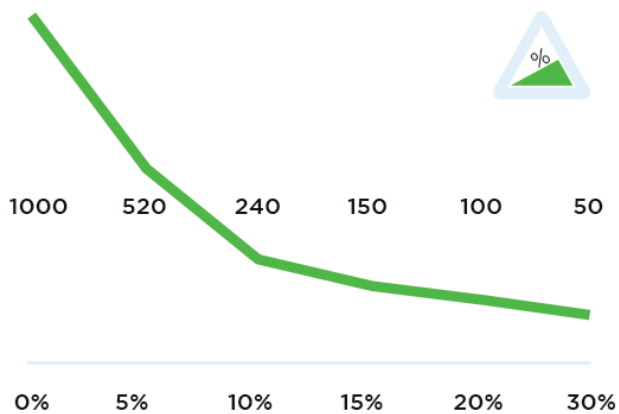

Gemeten met een trolley met 2 zwenkwielen en 2 bokwiel. Wieldiameter: 160mm

Dimensies

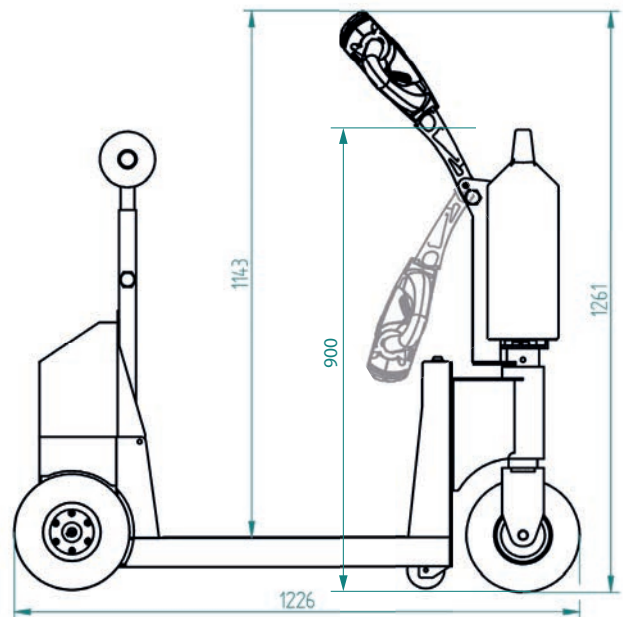
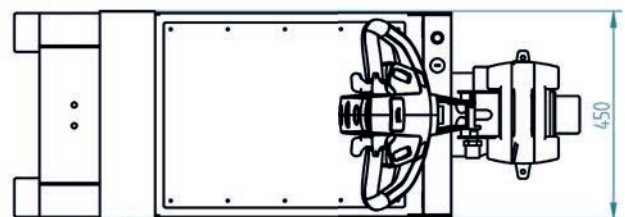

Standaard onderdelen



Motor 420W / 140rpm
(6911439X) met rem
Artikel Nr M1034



Accuconditiemeter 3-leds
Artikel Nr M0123



Acculader (extern)
AGM batterij 25,6V / 10A
Artikel Nr OPT0013



Battery Lithium groen
(LiFePO4) 25,6V / 36Ah
Artikel Nr OPT0106



Aandrijf wiel, massief rubber
zwart Ø 250 x 80mm
Artikel Nr M0248



Stuurwiel, massief rubber
zwart Ø 250 x 80mm
Item number M6019

Standaard onderdelen



Verstelbare disselkop
Artikel Nr M1002-0100



Omkeerschakelaar ROOD
Artikel Nr M0121-BBUT



2 programmeerbare
snelheden

Opties



UPGRADE:
Motor 530W / 170rpm
(6911534X) met rem
Artikel Nr OPT0025



Extra stekker voor
laden van Batterij
Artikel Nr OPT0001

Opties



UPGRADE: aandrijfwielen
Massief rubber, nonmarking
Grijs 3x Ø 250 x 80mm
Artikel Nr OPT0358



Claxon 90dB voor giet-
ijzeren disselkop M1002
Artikel Nr OPT0045



Claxon 90dB voor
stalen disselkop steun.
M1002-0100
Artikel Nr OPT0057



Claxon 103dB
Artikel Nr OPT0059



Noodstop
Artikel Nr OPT0063



Flitslamp voor gietijzeren
disselkop M1002
Artikel Nr OPT0076

Opties



Flitslamp voor
stalen disselkop supp.
M1002-0100
Artikel Nr OPT0065



Flitslamp op mast
Artikel Nr OPT0120



Geluids signaal
(bij vooruit rijden)
Artikel Nr OPT0253

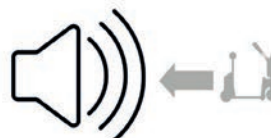

Geluids signaal
(bij achteruit rijden)
Artikel Nr OPT0254



Afstandsbediening
Artikel Nr OPT0026-3



Urenteller
Artikel Nr OPT0056

Opties



Antistatische strip
Artikel Nr OPT0058



Codeslot
Artikel Nr OPT0068



Document houder voor
gietijzeren disselkop M1002
Artikel Nr OPT0127



Document houder voor
stalen disselkop supp.
M1002-0100
Artikel Nr OPT0053



Veiligheids bumper
Artikel Nr OPT0079



Blauwe veiligheidslamp
Artikel Nr OPT0251

Opties



Vorbereitung
electrische haak
Artikel Nr OPT0143



Diagnose-stekker
aansluiting
Artikel Nr OPT0270



Contactslot
(ongelijke sleutel)
Artikel Nr OPT0145



Contactslot
(gelijke sleutel 701)
Artikel Nr OPT0146



Aan/uit draaischakelaar
Artikel Nr OPT0016



Parkeer vloersticker
Ø 60 cm
Artikel Nr OPT0245

Opties



Klantspecifieke
programmering
Artikel Nr OPT0170



Programmer Italsea
Artikel Nr D0003



U-frame voor Afval-
container 1000 l. / 1100 l.
Artikel Nr OPT0088

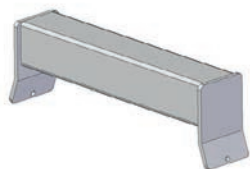

Lasbeugel
(profiel 50x50mm)
Artikel Nr OPT0032



Schroefbare trekkoker
(profiel 50x50mm)
Artikel Nr OPT0033



Spoedorder kosten
Artikel Nr SPOED

Opties



Detectie mat
Artikel Nr OPT0334

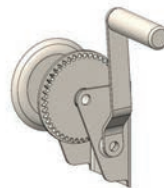

Lier (achter)
Artikel Nr OPT0008

Batterijen en opladers



Lader (extern) voor
Lithium batterij 25,6V / 10A
Artikel Nr OPT0013



Batterij Lithium groen
(LiFePO4) 25,6V / 36Ah
Artikel Nr OPT0106



Laadstation Lithium
muurmontage
Artikel Nr OPT0023

Batterijen en opladers



Laadstation Lithium
muurmontage (5x)
Artikel Nr OPT0029



UPGRADE naar:
enkelvoudig laadstation
(voor AGM of Lithium)
Artikel Nr OPT0261

Adapters



Basisdeel haak 90°
Artikel Nr H7030



Basisdeel haak 90°
(met extra veer)
Artikel Nr H7040



Basisdeel haak 90°
(manuelle bediening)
Artikel Nr H7090

Adapters



Uitslagbeperking haak 90°
Artikel Nr OPT0244

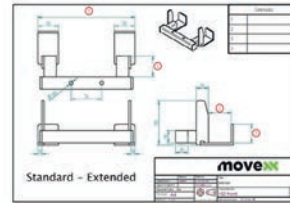

Klantspecifieke haak
*Afmetingen op detail-
tekening aangeven*
Artikel Nr HA5000

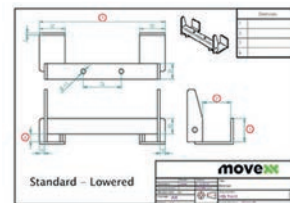

Klantspecifieke haak
(verlaagd)
*Afmetingen op detail-
tekening aangeven*
Artikel Nr HB5000

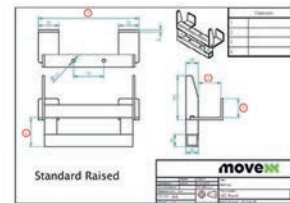

Klantspecifieke haak
(verhoogd)
*Afmetingen op detail-
tekening aangeven*
Artikel Nr HC5000

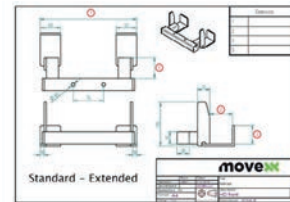

Klantspecifieke haak
(verlengd)
*Afmetingen op detail-
tekening aangeven*
Artikel Nr HD5000

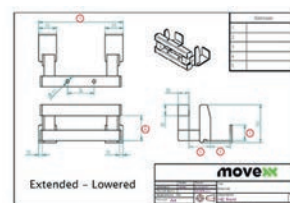

Klantspecifieke haak
(verlengd, verlaagd)
*Afmetingen op detail-
tekening aangeven*
Artikel Nr HE5000

Adapters

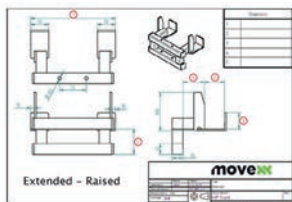

Klantspecifieke haak
(verlengd, verhoogd)
*Afmetingen op detail-
tekening aangeven*
Artikel Nr HF5000



Kogelkoppeling Ø 50mm
(incl. adapter)
Artikel Nr H0068



Haak voor LKE Plattform-
wagen (Type X)
Artikel Nr H0076



Haak K-Hartwall dolly
(DOS1617/1636, 25°)
Artikel Nr H0083

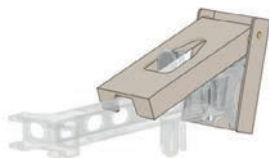

Haakblokkering (RVS)
Artikel Nr OPT0012



Electrische hefmodule
voor haak
Artikel Nr OPT0050

Adapters



Electrische borgmodule
voor haak
Artikel Nr OPT0129



Pen voor trekstang Ø16
Artikel Nr H0064

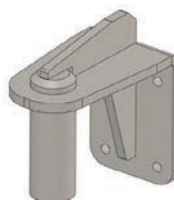

Pen voor trekstang Ø35
Artikel Nr H0144



Aanhangerkoppeling met
frame, pen Ø25
Artikel Nr H0062



Trekhaak voor Movexx
E-frame
(geschikt voor OPT0067)
Artikel Nr H0070

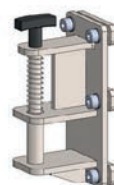

Veerkoppeling, pen Ø16
Artikel Nr H0120

Adapters



Pen voor trekstang Ø15
Artikel Nr H0071



Pen voor trekstang Ø10
Artikel Nr H0072



Klaphaak voor bloemenkar
Artikel Nr OPT0099



Klaphaak Ø16
Artikel Nr H0128-D16



Klaphaak Ø20
Artikel Nr H0128-D20



Klaphaak Ø25
Artikel Nr H0128-D25

Adapters



Klaphaak Ø27
Artikel Nr H0128-D27



Klaphaak Ø32
Artikel Nr H0128-D32



Klaphaak Ø35
Artikel Nr H0128-D35

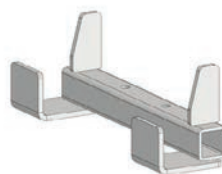

HA270.43.40.0.0
Haak voor 40 mm profiel
(K-Hartwall pallet trolley;
DOS1870)
Artikel Nr H0003

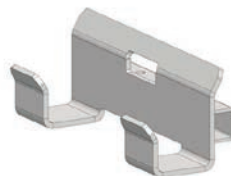

HA245.55.45.15.0
Haak voor 50 mm profiel
Artikel Nr H0004

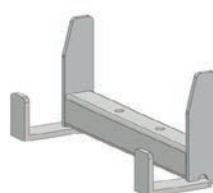

HA250.43.35.0.0
Haak voor 40 mm profiel
Artikel Nr H0051

Adapters

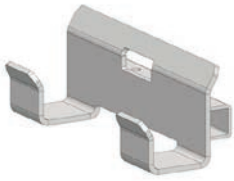

HB245.43.30.5.0
Haak voor 40 mm profiel
Artikel Nr H0054

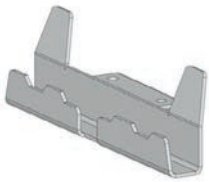

HA250.23.27.0.0
Haak voor 20 mm profiel
Artikel Nr H0067

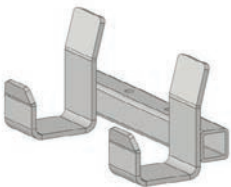

HB245.60.45.30.0
FEIL kunststof rolcontainer
Artikel Nr H0092



HA250.29.30.0.0
Haak voor 25 mm profiel
Artikel Nr H0094

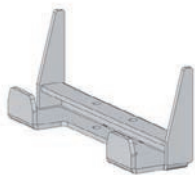

HA250.33.30.0.0
Haak voor 30 mm profiel
Artikel Nr H0095

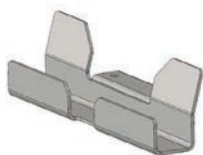

HA250.35.30.0.0
Haak voor 30 mm profiel
(voor meubelkar)
Artikel Nr H0097

Adapters

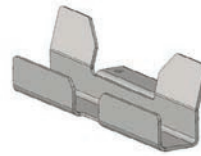

HF242.23.30.15.20
Haak voor 20 mm profiel
(hospital logistics)
Artikel Nr H0116

Meest voorkomende onderdelen



Batterij Lithium groen
(LiFePO4) 25,6V / 36Ah
Artikel Nr OPT0106



Lader (extern) voor
Lithium batterij, 25,6V / 10A
Artikel Nr OPT0013



Batterij geleider (RVS)
Artikel Nr M0482



Stekker SB50
Artikel Nr M0105

Meest voorkomende onderdelen



Belly button ROOD
Artikel Nr M0121-BBUT



Schakelknop (2x) groen
Artikel Nr M0121-KNOP-GROEN



Schakelaar disselkop
excl. knoppen
Artikel Nr M0121-FLIPPER



Veer/as gaspedaal
Artikel Nr M0121-4



Schakelaar FAST/SLOW
disselkop groen
Artikel Nr M0121-SPEED-GROEN



Schakelaar ON/OFF
disselkop groen
Artikel Nr M0121-AANUIT-GROEN

Meest voorkomende onderdelen



Kraagbus
Ø8 / 12 x 6, 16 x 2 mm
Artikel Nr M4038



Borgpen
M16x1,5mm
Artikel Nr M0001



Afdekplaat disselkop
Artikel Nr M0898



Torsieveer voor haak
Artikel Nr M0116



Vulbus voor veer
Artikel Nr M0116-1



Italsea rijregelaar
in 24V / 36 bat,
in 35A / I_{max} 90A
Artikel Nr M1124

Most common spareparts



Koolborstels (set van 4)
voor motor 420W - 750W
Artikel Nr M1037



Accuconditiemeter 3-leds
Artikel Nr M0123



Kabelboom 7
Artikel Nr M2304



Zekering 5A
Artikel Nr M0506



Fuse Maxi 50A
Artikel Nr M0220



Aandrijf wiel, massief rubber
zwart Ø 250 x 80mm
Artikel Nr M0248

Most common spareparts



Aandrijf wiel, massief rubber
Nonmarking
Gray Ø 250 x 80mm
Artikel Nr M0115



Stuurwiel, massief rubber
zwart Ø 250 x 80 mm
Artikel Nr M6019



Stuurwiel, massief rubber,
non-marking
Grijs Ø 250 x 80 mm
Artikel Nr M0696



Rubber wiel
Zwart Ø 80 mm
Artikel Nr M0319

toepassingen



moveXX
driven by brain power

ASP
Handling

ASP bvba
Baanakkerweg 3
B-3060 Bertem

+32 (0)16 36 12 24
info@asp-online.be
www.asp-online.be