



Movexx **T1500**  
OPTIES & ONDERDELEN  
**2019**

## Specificaties

### Technische gegevens

<b>Frame</b>	Staal, gepoedercoat
<b>Aandrijving</b>	24V DC, 600W, 100 toeren/min
<b>Gewicht</b>	105 kg (incl. accu)
<b>Gew. aanhanger</b>	Max. 1500 kg
<b>Accu</b>	Wisselbare accupack
<b>Snelheid</b>	Max. 4,7 km/h, vrij programmeerbaar
<b>Aandrijfwielen</b>	Massief rubber 250x80 mm
<b>Werkhoogte</b>	770-1177 mm (variabel)
<b>Geluidsniveau</b>	63,8 dB
<b>Gebruikers temp.</b>	-10 °C / 40 °C
<b>Bescherm klasse</b>	Machine IP44

© 2019 Movexx International B.V. The images shown are used for illustration purposes only and may differ from the products indicated. No rights can therefore be derived from it. Printing errors are subject to change.

## Trekkracht (in kg)

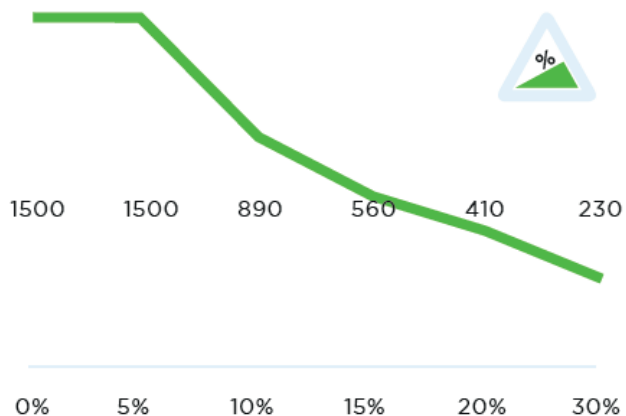

Gemeten met een trolley met 2 zwenkwielen en 2 bokwheels. Wieldiameter: 160mm

## Dimensies

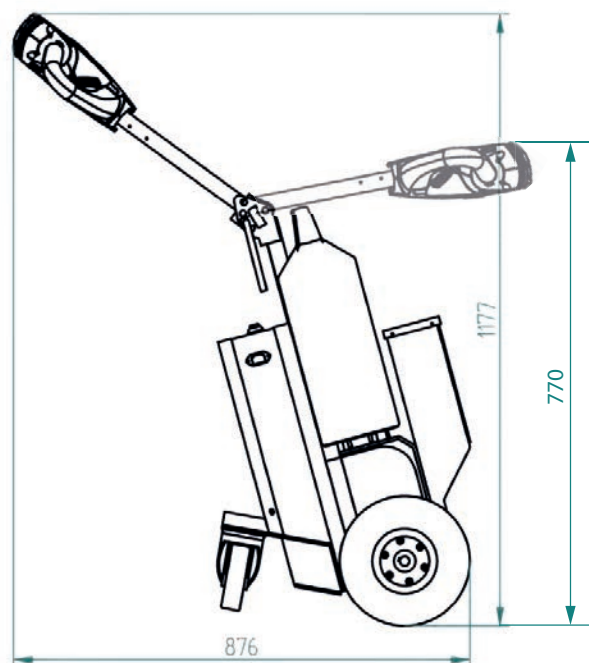
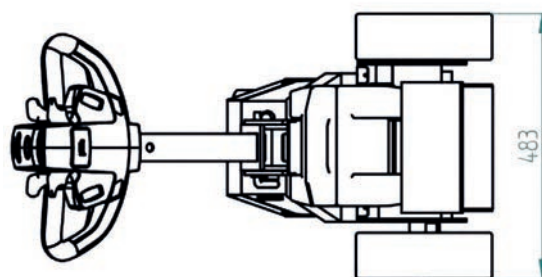

## Standaard onderdelen



Motor 600W / 100rpm  
(6911413X) met rem  
**Artikel Nr M2098**



Accuconditiemeter 3-leds  
**Artikel Nr M0123**



Acculader (extern)  
AGM batterij 24V / 5A  
**Artikel Nr OPT0009**



Batterij AGM-VRLA groen  
24V / 22Ah  
**Artikel Nr OPT0110**



Aandrijf wiel, massief rubber  
zwart Ø 250 x 80mm  
**Artikel Nr M0248**



Verstelbare disselkop  
**Artikel Nr M1726-0300**

## Standaard onderdelen



Omkeerschakelaar ROOD  
**Artikel Nr M0121-BBUT**



2 programmeerbare  
snelheden

## Opties



Extra stekker voor  
laden van Batterij  
**Artikel Nr OPT0001**



UPGRADE: nonmarking  
Volrubber aandrijfwielen  
2x grijs Ø 250 x 80mm  
**Artikel Nr OPT0359**



UPGRADE:  
Schuimbanden  
2x zwart Ø 250 x 80mm  
**Artikel Nr OPT0360**

## Opties



UPGRADE: aandrijfwielen  
geschuimd, non-marking  
Grijs 2x Ø 250 x 80mm  
**Artikel Nr OPT0361**



Claxon 90dB voor  
stalen disselkop steun  
**Artikel Nr OPT0057**



Claxon 103dB  
**Artikel Nr OPT0059**



Noodstop  
**Artikel Nr OPT0063**



Flitslamp voor  
stalen disselkop steun  
**Item number OPT0065**



Geluids signaal  
(bij vooruit rijden)  
**Artikel Nr OPT0253**

## Opties

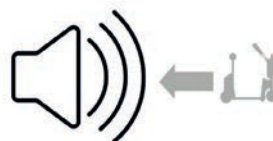

Geluids signaal  
(bij achteruit rijden)  
**Artikel Nr OPT0254**



Afstandsbediening  
**Artikel Nr OPT0026-4**



Urenteller  
**Artikel Nr OPT0056**



Antistatische strip  
**Artikel Nr OPT0058**



Codeslot  
**Artikel Nr OPT0068**



Document houder voor  
stalen disselkop steun  
**Artikel Nr OPT0053**

## Opties



Vorbereiding  
electrische haak  
**Artikel Nr OPT0143**



Beschermkap voor  
electrische aansluiting  
**Artikel Nr OPT0263**

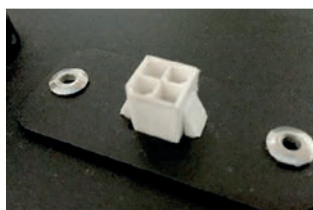

Diagnose-stekker  
aansluiting  
**Artikel Nr OPT0270**



Contactslot  
(ongelijke sleutel)  
**Artikel Nr OPT0145**



Contactslot  
(gelijke sleutel 701)  
**Artikel Nr OPT0146**



Aan/uit draaischakelaar  
**Artikel Nr OPT0016**

## Opties



Parkeer vloersticker  
Ø 60 cm  
**Artikel Nr OPT0245**



Klantspecifieke  
programmering  
**Artikel Nr OPT0170**



Programmer Italsea  
**Artikel Nr D0003**



Frame voor  
4-wiel afvalcontainers  
**Artikel Nr OPT0085**

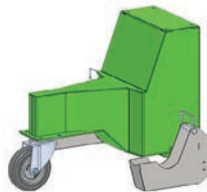

Adaptor voor  
Airport trolley  
**Artikel Nr OPT0325**

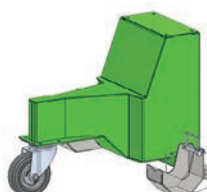

Adaptor voor  
winkelwagens  
**Artikel Nr OPT0326**

## Opties

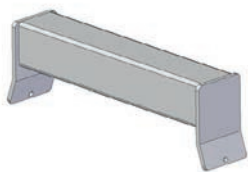

Lasbeugel  
(profiel 50x50mm)  
**Artikel Nr OPT0032**



Schroefbare trekkoker  
(profiel 50x50mm)  
**Artikel Nr OPT0033**



Bevestiging voor  
winkelwagen  
**Artikel Nr OPT0040**



Spedorder kosten  
**Artikel Nr SPOED**



Frame voor  
770 l. and 240 l. container  
**Artikel Nr OPT0375**

## Batterijen en opladers



Batterij AGM-VRLA groen  
24V / 22Ah  
**Artikel Nr OPT0110**



Lader (extern) voor  
AGM batterij, 24V / 5A  
**Artikel Nr OPT0009**



Batterij Lithium groen  
(LiFePO4) 25,6V / 36Ah  
**Artikel Nr OPT0106**



Lader (extern) voor  
Lithium batterij 25,6V / 10A  
**Artikel Nr OPT0013**



UPGRADE naar Lithium  
batterij + lader  
**Artikel Nr OPT0107**



Laadstation AGM  
muurmontage  
**Artikel Nr OPT0015**

## Batterijen en opladers



Laadstation Lithium  
muurmontage  
**Artikel Nr OPT0023**



Laadstation Lithium  
muurmontage (5x)  
**Artikel Nr OPT0029**



Laadstation AGM  
muurmontage (5x)  
**Artikel Nr OPT0039**



UPGRADE naar:  
enkelvoudig laadstation  
(voor AGM of Lithium)  
**Artikel Nr OPT0261**

## Adapters



Basisdeel haak 15°  
**Artikel Nr H701**

## Adapters



Basisdeel haak 15°  
(met extra veer)  
**Artikel Nr H7020**



Basisdeel HD-haak 15°  
(verlaagd)  
**Artikel Nr H7050**



Basisdeel HD-haak 15°  
(verhoogd)  
**Artikel Nr H7060**



Uitslagbeperking haak 15°  
**Artikel Nr OPT0218**

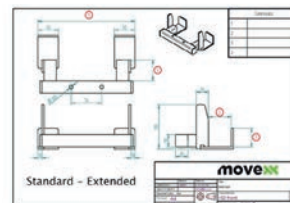

Klantspecifieke haak  
*Afmetingen op detail-  
tekening aangeven*  
**Artikel Nr HA5000**

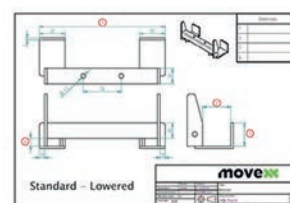

Klantspecifieke haak  
(verlaagd)  
*Afmetingen op detail-  
tekening aangeven*  
**Artikel Nr HB5000**

## Adapters

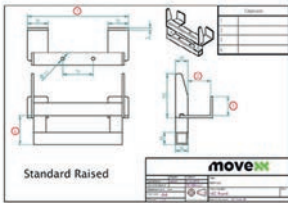

Klantspecifieke haak  
(verhoogd)  
*Afmetingen op detail-  
tekening aangeven*  
**Artikel Nr HC5000**

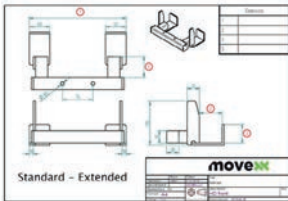

Klantspecifieke haak  
(verlengd)  
*Afmetingen op detail-  
tekening aangeven*  
**Artikel Nr HD5000**

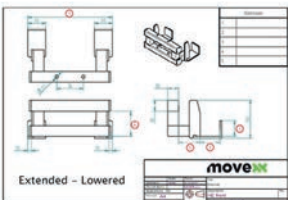

Klantspecifieke haak  
(verlengd, verlaagd)  
*Afmetingen op detail-  
tekening aangeven*  
**Artikel Nr HE5000**

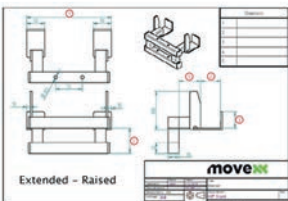

Klantspecifieke haak  
(verlengd, verhoogd)  
*Afmetingen op detail-  
tekening aangeven*  
**Artikel Nr HF5000**



Haak voor LKE Plattform-  
wagen (Type X)  
**Artikel Nr H0076**

## Adapters

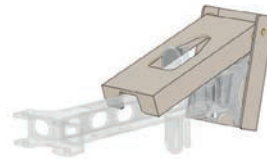

Haakblokkering RVS  
**Artikel Nr OPT0012**



Electrische hefmodule  
voor haak  
**Artikel Nr OPT0050**



Electrische borgmodule  
voor haak  
**Artikel Nr OPT0129**



Klemmende Haak (HD)  
(van 0 - 100mm)  
**Artikel Nr H0152**

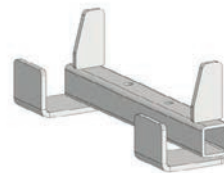

HA270.43.40.0.0  
Haak voor 40 mm profiel  
(K-Hartwall pallet trolley;  
DOS1870)  
**Artikel Nr H0003**



Haak K-Hartwall dolly  
(DOS1617/1636, 25°)  
**Artikel Nr H0086**

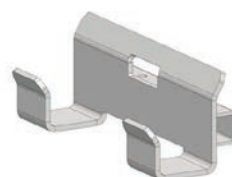

HA245.55.45.15.0  
Haak voor 50 mm profiel  
**Artikel Nr H0004**



## Adapters

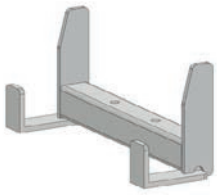

HA250.43.35.0.0  
Haak voor 40 mm profiel  
**Artikel Nr H0051**

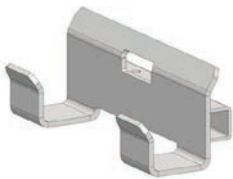

HB245.43.30.5.0  
Haak voor 40 mm profiel  
**Artikel Nr H0054**

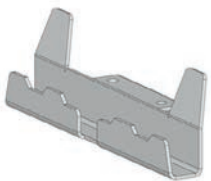

HA250.23.27.0.0  
Haak voor 20 mm profiel  
**Artikel Nr H0067**

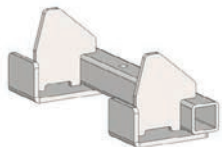

HD245.10.35.0.50  
EMKA voor broedkar haak  
**Artikel Nr H0090**

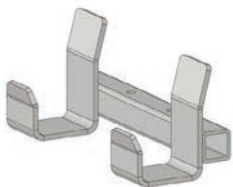

HB245.60.45.30.0  
FEIL kunststof rolcontainer  
**Artikel Nr H0092**



HC250.28.25.0.0  
Haak voor 25 mm profiel  
**Artikel Nr H0094**

## Adapters

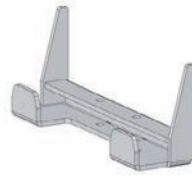

HA250.33.30.0.0  
Haak voor 30 mm profiel  
**Artikel Nr H0095**

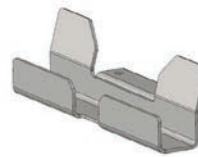

HA250.35.30.0.0  
Haak voor 30 mm profiel  
(voor Meubelkar)  
**Artikel Nr H0097**

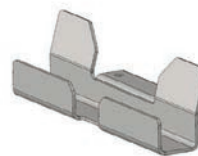

HF242.23.30.15.20  
Haak voor 20 mm profiel  
(hospital logistics)  
**Artikel Nr H0116**

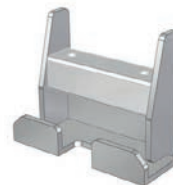

HB135.18.20.35.0  
Haak voor 15 mm profiel  
(K-Hartwell dolly 400x600)  
**Artikel Nr H0125**

## Meest voorkomende onderdelen



Batterij AGM-VRLA groen  
24V / 22Ah  
**Artikel Nr OPT0110**



Lader (extern) voor  
AGM batterij, 24V / 5A  
**Artikel Nr OPT0009**



Batterij Lithium groen  
(LiFePO4) 25,6V / 36Ah  
**Artikel Nr OPT0106**



Lader (extern) voor  
Lithium batterij, 25,6V / 10A  
**Artikel Nr OPT0013**



Batterij geleider (RVS)  
**Artikel Nr M0482**



Stekker SB50  
**Artikel Nr M0105**

## Meest voorkomende onderdelen



Belly button ROOD  
**Artikel Nr M0121-BBUT**



Schakelknop (2x) groen  
**Artikel Nr M0121-KNOP-GROEN**



Schakelaar disselkop  
excl. knoppen  
**Artikel Nr M0121-FLIPPER**



Veer/as gaspedaal  
**Artikel Nr M0121-4**



Schakelaar FAST/SLOW  
disselkop groen  
**Artikel Nr M0121-SPEED-GROEN**



Schakelaar ON/OFF  
disselkop groen  
**Artikel Nr M0121-AANUIT-GROEN**

## Meest voorkomende onderdelen



Kraagbus  
10 x 12 x 9 mm  
**Artikel Nr M0775**



Borgpen  
M16x1,5mm  
**Artikel Nr M0001**



Torsieveer voor haak  
**Artikel Nr M0116**



Vulbus voor veer  
**Artikel Nr M0116-1**



Italsea rijregelaar  
in 24V / 36 bat,  
in 35A / I<sub>max</sub> 90A  
**Artikel Nr M1124**



Koolborstels (set van 4)  
voor motor 600W  
**Artikel Nr M1037**

## Meest voorkomende onderdelen



Accuconditiemeter 3-leds  
**Artikel Nr M0123**



Kabelboom  
**Artikel Nr M1127-M050**



Zekering 5A  
**Artikel Nr M0506**



Zekering Maxi 80A  
**Artikel Nr M0191**



Aandrijf wiel, massief rubber  
zwart Ø 250 x 80mm  
**Artikel Nr M0248**



Aandrijf wiel, massief rubber  
Nonmarking  
Gray Ø 250 x 80mm  
**Item number M0115**

## Häufigste Ersatzteile



Aandrijf wiel, gevuld met  
schuim, zwart  
Ø 250 x 80mm  
**Item number M0091**



Zwenkwiel  
zwart, Ø 125 mm  
**Artikel Nr M0110**

# toepassingen



**moveXX**  
driven by brain power

**ASP**  
Handling

ASP bvba  
Baanakkerweg 3  
B-3060 Bertem

+32 (0)16 36 12 24  
info@asp-online.be  
www.asp-online.be