



Movexx **T1000-D**
OPTIES & ONDERDELEN
2019

Specificaties

Technische gegevens

Frame	Staal, gepoedercoat
Aandrijving	24V DC, 300W, 100 toeren/min
Gewicht	55 kg (incl. accu)
Gew. aanhanger	Max. 1000 kg
Accu	Wisselbare accupack
Snelheid	Max. 5 km/h, vrij programmeerbaar
Aandrijfwielen	Massief rubber 250x80 mm
Werkhoogte	750-985 mm (variabel)
Geluidsniveau	63,8 dB
Gebruikers temp.	-10 °C / 40 °C
Bescherm klasse	Machine IP44

Standard Features

© 2019 Movexx International B.V. The images shown are used for illustration purposes only and may differ from the products indicated. No rights can therefore be derived from it. Printing errors are subjected to change.

Trekkracht (in kg)

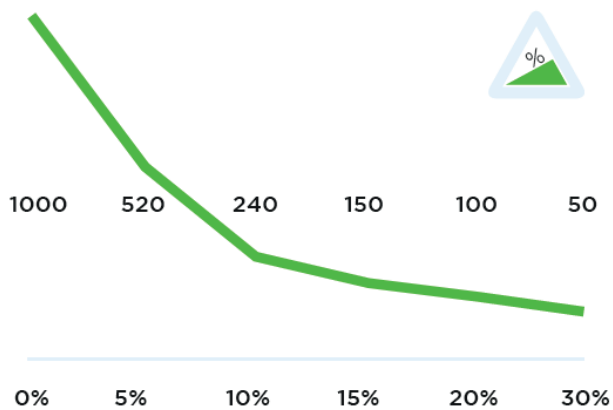

Gemeten met een trolley met 2 zwenkwielen en 2 bokwheels. Wiel diameter: 160mm

Dimensies

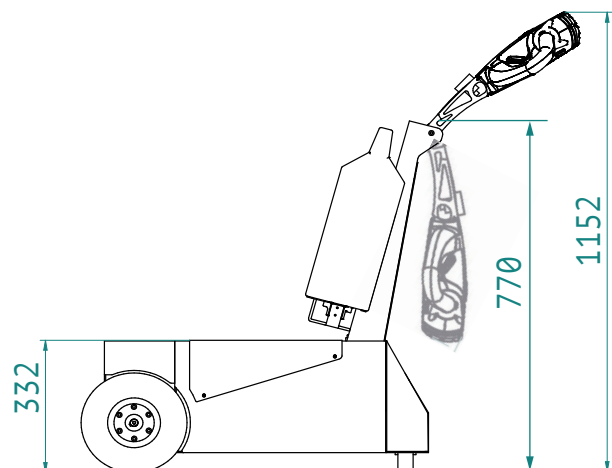
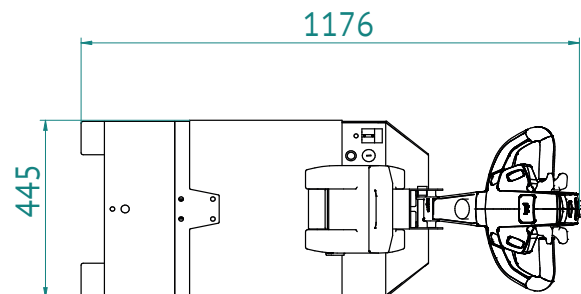

Standaard onderdelen



Motor 300W / 100rpm
(6911345X) zonder rem
Artikel Nr M1032



Accuconditiemeter 3-leds
Artikel Nr M0123



Acculader (extern)
AGM batterij 24V / 5A
Artikel Nr OPT0009



Batterij AGM-VRLA groen
24V / 22Ah
Artikel Nr OPT0110



Aandrijfwiel, massief rubber
zwart Ø 250 x 80mm
Artikel Nr M0248



Zwenkwiel
zwart, Ø 125 mm
Artikel Nr M0110

Standaard onderdelen



Verstelbare disselkop
Artikel Nr M1002-0100



Omkeerschakelaar ROOD
Artikel Nr M0121-BBUT



2 programmeerbare
snelheden

Opties



Extra stekker voor
laden van Batterij
Artikel Nr OPT0001



UPGRADE: aandrijfwielen
massief rubber, nonmarking
Grijs 2x Ø 250 x 80mm
Artikel Nr OPT0359

Opties



UPGRADE: aandrijfwielen
geschuimd
Zwart 2x Ø 250 x 80mm
Artikel Nr OPT0360



UPGRADE: aandrijfwielen
geschuimd, non-marking
Grijs 2x Ø 250 x 80mm
Artikel Nr OPT0361



Claxon 90dB voor giet-
ijzeren disselkop M1002
Artikel Nr OPT0045



Claxon 90dB voor
stalen disselkop steun
M1002-0100
Artikel Nr OPT0057



Claxon 103dB
Artikel Nr OPT0059



Noodstop
Artikel Nr OPT0063

Opties



Flitslamp voor gietijzeren
disselkop steun M1002
Artikel Nr OPT0076



Flitslamp voor
stalen disselkop steun
M1002-0100
Item number OPT0065



Flitslamp op mast
Artikel Nr OPT0124



Geluids signaal
(bij vooruit rijden)
Artikel Nr OPT0253

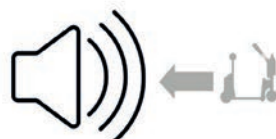

Geluids signaal
(bij achteruit rijden)
Artikel Nr OPT0254



Afstandsbediening
Artikel Nr OPT0026-1

Opties



Electromagnetische
parkeerrem
Artikel Nr OPT0004



Urenteller
Artikel Nr OPT0056



Antistatische strip
Artikel Nr OPT0058



Codeslot
Artikel Nr OPT0068



Document houder voor
gietijzeren disselkop M1002
Artikel Nr OPT0127



Document houder voor
stalen disselkop steun
M1002-0100
Artikel Nr OPT0053

Opties



Vorbereiding
electrische haak
Artikel Nr OPT0143

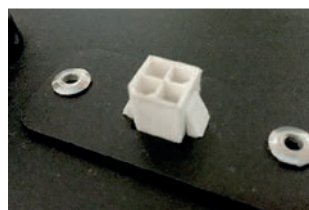

Diagnose-stekker
aansluiting
Artikel Nr OPT0270



Contactslot
(ongelijke sleutel)
Artikel Nr OPT0145



Contactslot
(gelijke sleutel 701)
Artikel Nr OPT0146



Aan/uit draaischakelaar
Artikel Nr OPT0016



Parkeer vloersticker
Ø 60 cm
Artikel Nr OPT0245

Opties



Klantspecifieke
programmering
Artikel Nr OPT0170



Programmer Italsea
Artikel Nr D0003



Maximaal gewicht
Artikel Nr OPT0172



U-frame voor Afval-
container 1000 l. / 1100 l.
Artikel Nr OPT0088



Adapter voor
2 wielige afvalbakken
Artikel Nr OPT0151

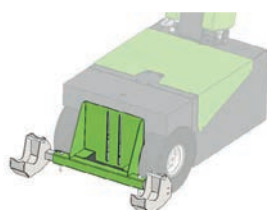

Adapter voor
winkelwagens (90°)
Artikel Nr OPT0324

Opties

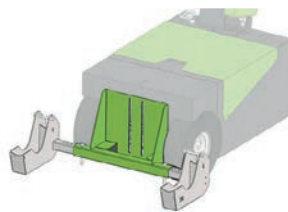

Adapter voor
Airportrolley (90°)
Artikel Nr OPT0327

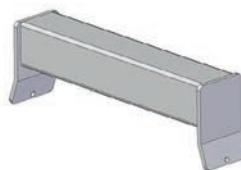

Lasbeugel
(profiel 50x50mm)
Artikel Nr OPT0032



Schroefbare trekkoker
(profiel 50x50mm)
Artikel Nr OPT0033



Bevestiging voor
winkelwagen
Artikel Nr OPT0040



Spoedorder kosten
Artikel Nr SPOED

Batterijen en opladers



Batterij AGM-VRLA groen
24V / 22Ah
Artikel Nr OPT0110



Lader (extern) voor
AGM batterij, 24V / 5A
Artikel Nr OPT0009



Batterij Lithium groen
(LiFePO4) 25,6V / 36Ah
Artikel Nr OPT0106



Lader (extern) voor
Lithium batterij 25,6V / 10A
Artikel Nr OPT0013



UPGRADE naar Lithium
batterij + lader
Artikel Nr OPT0107



Laadstation AGM
muurmontage
Artikel Nr OPT0015

Batterijen en opladers



Laadstation Lithium
muurmontage
Artikel Nr OPT0023



Laadstation Lithium
muurmontage (5x)
Artikel Nr OPT0029



Laadstation AGM
muurmontage (5x)
Artikel Nr OPT0039



UPGRADE naar:
enkelvoudig laadstation
(voor AGM of Lithium)
Artikel Nr OPT0261

Adapters



Basisdeel haak 90°
Artikel Nr H7030

Adapters



Basisdeel haak 90°
(met extra veer)
Artikel Nr H7040



Basisdeel HD-haak 90°
(verlaagd)
Artikel Nr H7070

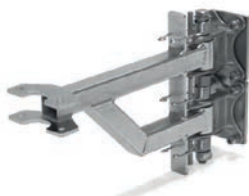

Basisdeel HD-haak 90°
(verhoogd)
Artikel Nr H7080



Basisdeel haak 90°
(manuelle bediening)
Artikel Nr H7090



Uitslagbeperking haak 90°
Artikel Nr OPT0244

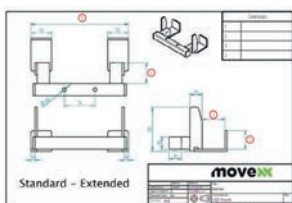

Klantspecifieke haak
*Afmetingen op detail-
tekening aangeven*
Artikel Nr HA5000

Adapters

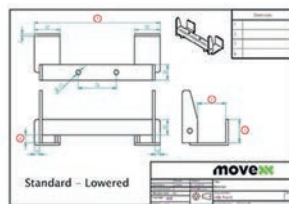

Klantspecifieke haak
(verlaagd)
*Afmetingen op detail-
tekening aangeven*
Artikel Nr HB5000

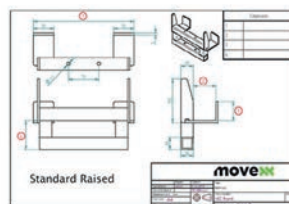

Klantspecifieke haak
(verhoogd)
*Afmetingen op detail-
tekening aangeven*
Artikel Nr HC5000

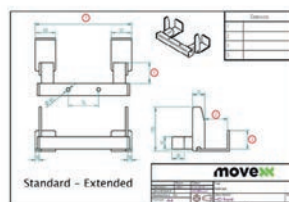

Klantspecifieke haak
(verlengd)
*Afmetingen op detail-
tekening aangeven*
Artikel Nr HD5000

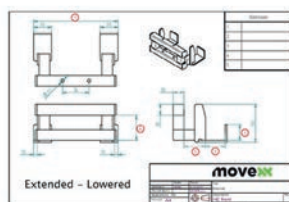

Klantspecifieke haak
(verlengd, verlaagd)
*Afmetingen op detail-
tekening aangeven*
Artikel Nr HE5000

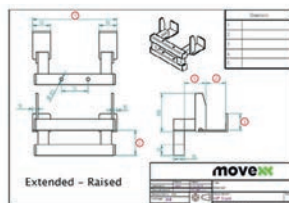

Klantspecifieke haak
(verlengd, verhoogd)
*Afmetingen op detail-
tekening aangeven*
Artikel Nr HF5000



Kogelkoppeling Ø 50mm
(incl. adapter)
Artikel Nr H0068

Adapters



Haak voor LKE Plattform-
wagen (Type X)
Artikel Nr H0076



Haak K-Hartwall dolly
(DOS1617/1636, 90°)
Artikel Nr H0083



Electrische hefmodule
voor haak
Artikel Nr OPT0050

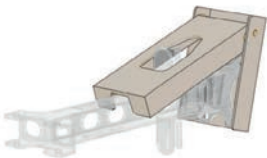

Haakblokkering (RVS)
Artikel Nr OPT0012



Electrische borgmodule
voor haak
Artikel Nr OPT0129



Pen voor trekstang Ø16
Artikel Nr H0064

Adapters



Aanhangerkoppeling met
frame, pen Ø25
Artikel Nr H0062



Trekhaak voor Movexx
E-frame
(geschikt voor OPT0067)
Artikel Nr H0070

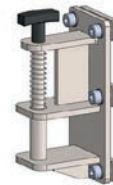

Veerkoppeling, pen Ø16
Artikel Nr H0120



Pen voor trekstang Ø15
Item number H0071



Pen voor trekstang Ø10
Item number H0072



Klaphaak
voor bloemenkar
Item number OPT0099

Adapters



Klaphaak Ø16
Artikel Nr H0128-D16



Klaphaak Ø20
Artikel Nr H0128-D20



Klaphaak Ø25
Artikel Nr H0128-D25



Klaphaak Ø27
Artikel Nr H0128-D27



Klaphaak Ø32
Artikel Nr H0128-D32



Klaphaak Ø35
Artikel Nr H0128-D35

Adapters

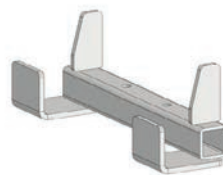

HA270.43.40.0.0
Haak voor 40 mm profiel
(K-Hartwall pallet trolley;
DOS1870)
Artikel Nr H0003

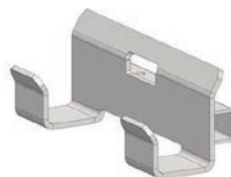

HA245.55.45.15.0
Haak voor 50 mm profiel
Artikel Nr H0004

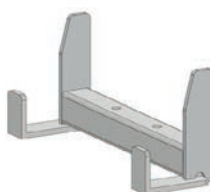

HA250.43.35.0.0
Haak voor 40 mm profiel
Artikel Nr H0051

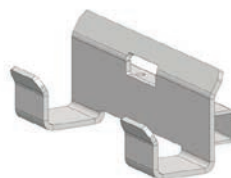

HB245.43.30.5.0
Haak voor 40 mm profiel
Artikel Nr H0054

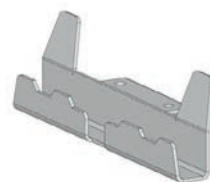

HA250.23.27.0.0
Haak voor 20 mm profiel
Artikel Nr H0067

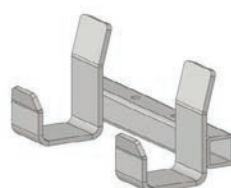

HB245.60.45.30.0
FEIL kunststof rolcontainer
Artikel Nr H0092

Adapters

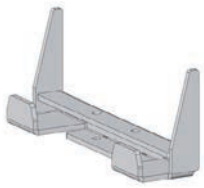

HA250.29.30.0.0
Haak voor 25 mm profiel
Artikel Nr H0094

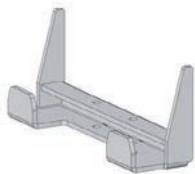

HA250.33.30.0.0
Haak voor 30 mm profiel
Artikel Nr H0095

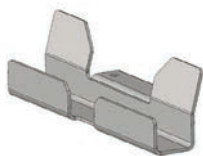

HA250.35.30.0.0
Haak voor 30 mm profiel
(voor meubelkar)
Artikel Nr H0097

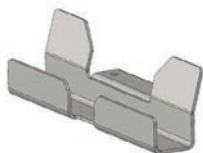

HF242.23.30.15.20
Haak voor 20 mm profiel
(hospital logistics)
Artikel Nr H0116

Meest voorkomende onderdelen



Lader (extern) voor
AGM batterij, 24V / 5A
Artikel Nr OPT0009



Batterij Lithium groen
(LiFePO4) 25,6V / 36Ah
Artikel Nr OPT0106



Lader (extern) voor
Lithium batterij, 25,6V / 10A
Artikel Nr OPT0013



Batterij geleider (RVS)
Artikel Nr M0482



Stekker SB50
Artikel Nr M0105

Meest voorkomende onderdelen



Batterij AGM-VRLA groen
24V / 22Ah
Artikel Nr OPT0110



Belly button ROOD
Artikel Nr M0121-BBUT

Meest voorkomende onderdelen



Schakelknop (2x) groen
Artikel Nr M0121-KNOP-GROEN



Schakelaar disselkop
excl. knoppen
Artikel Nr M0121-FLIPPER



Veer/as gaspedaal
Artikel Nr M0121-4



Schakelaar FAST/SLOW
disselkop groen
Artikel Nr M0121-SPEED-GROEN



Schakelaar ON/OFF
disselkop groen
Artikel Nr M0121-AANUIT-GROEN



Kraagbus
Ø8 / 12 x 6, 16 x 2 mm
Artikel Nr M4038

Meest voorkomende onderdelen



Borgpen
M16x1,5mm
Artikel Nr M0001



Afdekplaat disselkop
Artikel Nr M0898



Torsieveer voor haak
Artikel Nr M0116



Vulbus voor veer
Artikel Nr M0116-1



Italsea rijregelaar
in 24V / 36 bat,
in 10A / I_{max} 45A
Artikel Nr M1122



Koolborstels (set van 4)
voor motor 300W
Artikel Nr M0186

Meest voorkomende onderdelen



Accuconditiometer 3-leds
Artikel Nr M0123



Kabelboom
Artikel Nr M1127-M050



Zekering 5A
Artikel Nr M0506



Zekering Maxi 80A
Artikel Nr M0191



Aandrijf wiel, massief rubber
zwart Ø 250 x 80mm
Artikel Nr M0248



Aandrijf wiel, massief rubber
Nonmarking
Gray Ø 250 x 80mm
Item number M0115

Meest voorkomende onderdelen



Aandrijf wiel, gevuld met
schuim, zwart
Ø 250 x 80mm
Item number M0091



Zwenkwiel
zwart, Ø 125 mm
Artikel Nr M0110

toepassingen



movexx
driven by brain power

ASP
Handling

ASP bvba
Baanakkerweg 3
B-3060 Bertem

+32 (0)16 36 12 24
info@asp-online.be
www.asp-online.be