



Movexx **T1000-Basic**
OPTIES & ONDERDELEN
2019



Specificaties

Technische gegevens

Frame	Staal, gepoedercoat
Aandrijving	24V DC, 300W, 100 toeren/min
Gewicht	43 kg (incl. accu)
Gew. aanhanger	Max. 1000 kg
Accu	Ingebouwd
Snelheid	Max. 5 km/h, vrij programmeerbaar
Aandrijfwielen	Massief rubber Ø 250x80 mm
Werkhoogte	1056 mm
Geluidsniveau	63,8 dB
Gebruikers temp.	-10 °C / 40 °C
Bescherm klasse	Machine IP44

© 2019 Movexx International B.V. The images shown are used for illustration purposes only and may differ from the products indicated. No rights can therefore be derived from it. Printing errors are subjected to change.

Trekkracht (in kg)

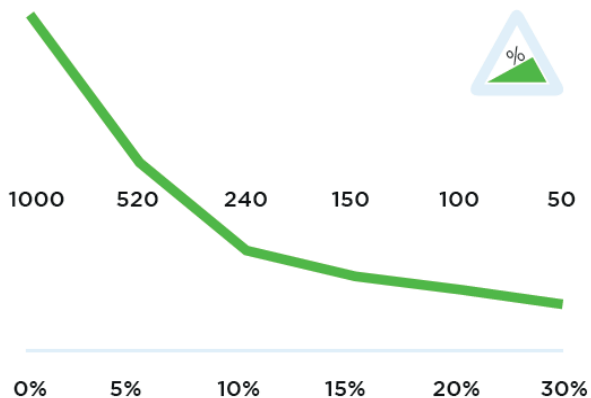

Gemeten met een trolley met 2 zwenkwielen en 2 bokwheels. Wiel diameter: 160mm

Dimensies

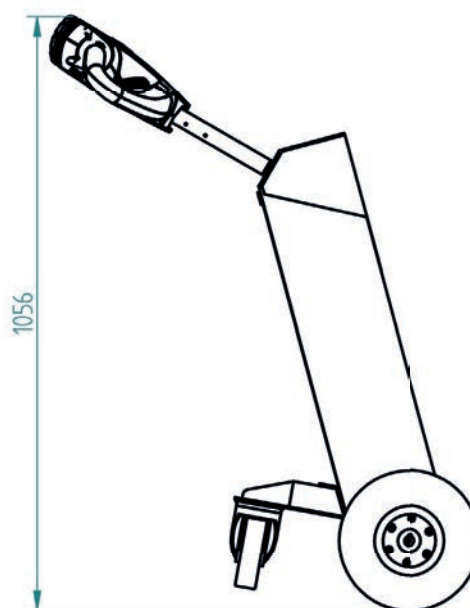
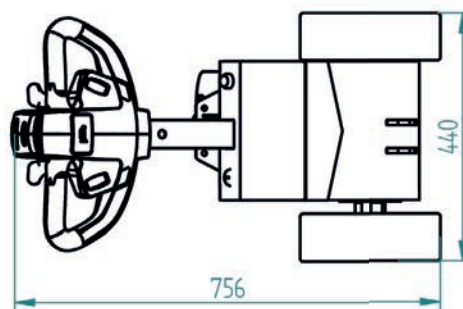

Standaard onderdelen



Motor 300W / 100rpm
(6911345X) zonder rem
Artikel Nr M1032



Batterij AGM-VRLA blok
12V / 22Ah
Item number M0076



Accuconditiemeter 3-leds
Artikel Nr M0123



Acculader (ingebouwd)
AGM batterij, 24V / 5A
+ externe conditiemeter
Artikel Nr M0246



Aandrijf wiel, massief rubber
zwart Ø 250 x 80mm
Artikel Nr M0248



Omkeerschakelaar ROOD
Artikel Nr M0121-BBUT

Standaard onderdelen



2 programmeerbare
snelheden

Opties



Extra stekker voor
laden van Batterij
Artikel Nr OPT0001



UPGRADE: aandrijfwielen
massief rubber, nonmarking
Grijs 2x Ø 250 x 80mm
Artikel Nr OPT0359



UPGRADE: aandrijfwielen
geschuimd
Zwart 2x Ø 250 x 80mm
Artikel Nr OPT0360



UPGRADE: aandrijfwielen
geschuimd, non-marking
Grijs 2x Ø 250 x 80mm
Artikel Nr OPT0361

Opties



Claxon 90dB voor
stalen disselkop supp.
M1002-0100
Artikel Nr OPT0057



Claxon 103dB
Item number OPT0059



Noodstop
Artikel Nr OPT0063



Flitslamp voor
stalen disselkop supp.
M1002-0100
Item number OPT0065



Geluids signaal
(bij vooruit rijden)
Artikel Nr OPT0253

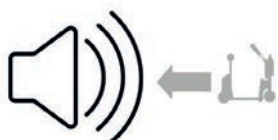

Geluids signaal
(bij achteruit rijden)
Artikel Nr OPT0254

Opties



Koppelstukbak
Artikel Nr OPT0014



Electromagnetische
parkeerrem
Artikel Nr OPT0004



Contragewicht
(voorzijde) 30kg
Artikel Nr OPT0044



Urenteller
Artikel Nr OPT0056



Antistatische strip
Artikel Nr OPT0058



Codeslot
Artikel Nr OPT0068

Opties



Document houder voor
stalen disselpop supp.
M1002-0100

Artikel Nr OPT0053



Vorbereitung
electrische haak

Artikel Nr OPT0143



Beschermkap voor
electrische aansluiting

Artikel Nr OPT0263



Diagnose-stekker
aansluiting

Artikel Nr OPT0270



Contactslot
(ongelijke sleutel)

Artikel Nr OPT0145



Contactslot
(gelijke sleutel 701)

Artikel Nr OPT0146

Opties



Aan/uit draaischakelaar

Artikel Nr OPT0016



Parkeer vloersticker
Ø 60 cm

Artikel Nr OPT0245



Klantspecifieke
programmering

Artikel Nr OPT0170



Programmer Italsea

Artikel Nr D0003



Frame voor
4-wiel afvalcontainers

Artikel Nr OPT0085

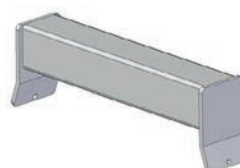

Lasbeugel
(profiel 50x50mm)

Artikel Nr OPT0032

Opties



Schroefbare trekkoker
(profiel 50x50mm)
Artikel Nr OPT0033



Bevestiging voor
winkelwagen
Artikel Nr OPT0040



Frame voor
770 l. and 240 l. container
Artikel Nr OPT0375

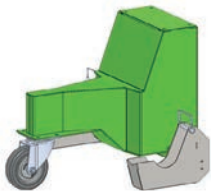

Adaptor voor
Airport trolley
Artikel Nr OPT0325



Adaptor voor
winkelwagens
Artikel Nr OPT0326



Spoedorder kosten
Artikel Nr SPOED

Batterijen en opladers



Batterij AGM-VRLA blok
12V / 22Ah
Item number M0076



Acculader (ingebouwd)
AGM batterij, 24V / 5A
+ externe conditiemeter
Artikel Nr M0246

Adapters



Basisdeel haak 15°
Artikel Nr H7010



Basisdeel haak 15°
(met extra veer)
Artikel Nr H7020



Uitslagbeperking haak 15°
Artikel Nr OPT0218

Adapters

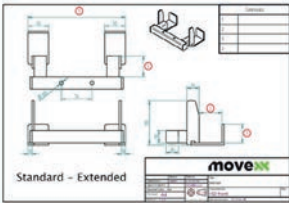

Klantspecifieke haak
*Afmetingen op detail-
tekening aangeven*
Artikel Nr HA5000

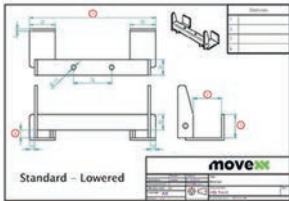

Klantspecifieke haak
(verlaagd)
*Afmetingen op detail-
tekening aangeven*
Artikel Nr HB5000

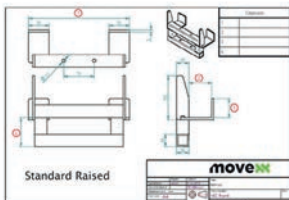

Klantspecifieke haak
(verhoogd)
*Afmetingen op detail-
tekening aangeven*
Artikel Nr HC5000

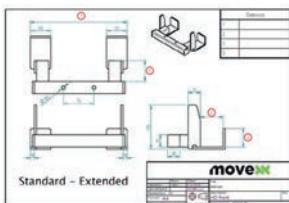

Klantspecifieke haak
(verlengd)
*Afmetingen op detail-
tekening aangeven*
Artikel Nr HD5000

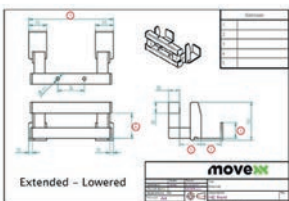

Klantspecifieke haak
(verlengd, verlaagd)
*Afmetingen op detail-
tekening aangeven*
Artikel Nr HE5000

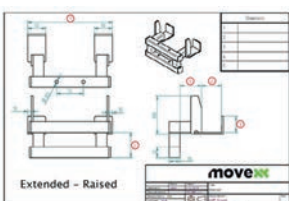

Klantspecifieke haak
(verlengd, verhoogd)
*Afmetingen op detail-
tekening aangeven*
Artikel Nr HF5000

Adapters



Haak voor LKE Plattform-
wagen (Type X)
Artikel Nr H0076

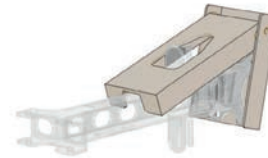

Haakblokkering
Artikel Nr OPT0012



Electrische hefmodule
voor haak
Artikel Nr OPT0050



Electrische borgmodule
voor haak
Artikel Nr OPT0129



Klemmende Haak RVS
Artikel Nr H0096



Klemmende Haak (HD)
(van 0 - 100mm)
Artikel Nr H0152

Adapters

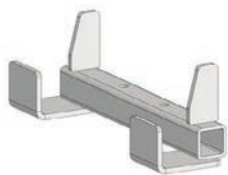

HA270.43.40.0.0
Haak voor 40 mm profiel
(K-Hartwall pallet trolley;
DOS1870)

Artikel Nr H0003

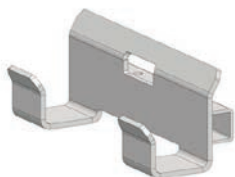

HA245.55.45.15.0
Haak voor 50 mm profiel

Artikel Nr H0004

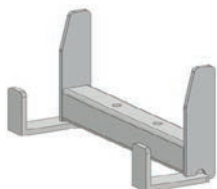

HA250.43.35.0.0
Haak voor 40 mm profiel

Artikel Nr H0051

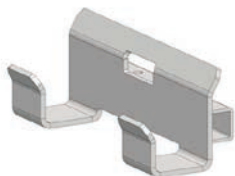

HB245.43.30.5.0
Haak voor 40 mm profiel

Artikel Nr H0054

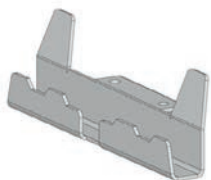

HA250.23.27.0.0
Haak voor 20 mm profiel

Artikel Nr H0067

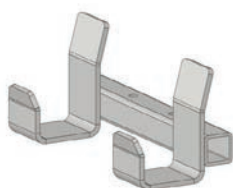

HB245.60.45.30.0
FEIL kunststof rolcontainer

Artikel Nr H0092

Adapters



HA250.28.25.0.0
Haak voor 25 mm profiel

Artikel Nr H0094

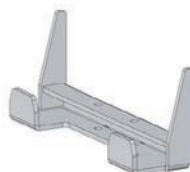

HA250.33.30.0.0
Haak voor 30 mm profiel

Artikel Nr H0095

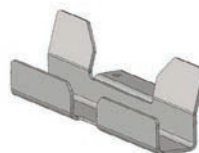

HF242.23.30.15.20
Haak voor 20 mm profiel
(hospital logistics)

Artikel Nr H0116

Meest voorkomende onderdelen



Batterij AGM-VRLA blok :
12V / 22Ah

Item number M0076



Acculader (ingebouwd)
AGM batterij, 24V / 5A
+ externe conditiemeter

Artikel Nr M0246

Meest voorkomende onderdelen



Belly button ROOD
Artikel Nr M0121-BBUT



Schakelknop (2) groen
Artikel Nr M0121-KNOP-GROEN



Schakelaar disselkop
excl. knoppen
Artikel Nr M0121-FLIPPER



Veer/as gaspedaal
Artikel Nr M0121-4



Schakelaar FAST/SLOW
disselkop groen
Artikel Nr M0121-SPEED-GROEN



Schakelaar ON/OFF
disselkop groen
Artikel Nr M0121-AANUIT-GROEN

Meest voorkomende onderdelen



Torsieveer voor haak
Artikel Nr M0116



Vulbus voor veer
Artikel Nr M0116-1



Italsea rijregelaar
in 24V / 36 bat,
in 10A / I_{max} 45A
Artikel Nr M1122



Koolborstels (set van 4)
voor motor 300W
Artikel Nr M0186



Accuconditiemeter
voor inbouw lader 3-leds
Artikel Nr M0318



Kabelboom 3
Artikel Nr M0133

Meest voorkomende onderdelen



Chassisdeel kabel
inbouwlader
Artikel Nr M0158-Stekker



Zekering 5A
Artikel Nr M0506



Zekering Maxi 40A
Artikel Nr M0254



Aandrijfwiël, massief rubber
zwart Ø 250 x 80mm
Artikel Nr M0248



€ 39.—
Zwenkwiel
zwart, Ø 125 mm
Artikel Nr M0110

toepassingen



movexx
driven by brain power

ASP
Handling

ASP bvba
Baanakkerweg 3
3060 Bertem

Tel +32 (0)16 36 12 24
info@asp-online.be
www.asp-online.be